

GOOLUGATUP SAILING CARNIVAL

4 – 14 JANUARY 2021

SAILING INSTRUCTIONS

Incorporating
Western Australian 29er State Championship and Optimist State Championship

The notation '[DP]' in a rule in the SI means that the penalty for a breach of that rule may, at the discretion of the Protest Committee (PC), be less than disqualification.

The Organising Authority (OA) is South of Perth Yacht Club Inc. (SoPYC).

1. RULES

1.1 The regatta will be governed by the following rules:

- a) The Racing Rules of Sailing (RRS).
- b) Australian Sailing Special Regulations Part 2 for Off The Beach Boats.
- c) Class rules of the respective classes (except where any of these are altered by these Sailing Instructions) will apply.
- d) The Sailing Instructions (SIs)
- e) There shall be an on-water observer on the course. Whilst afloat they may sound a whistle to indicate they have observed a racing incident.
- f) RRS Appendix T Arbitration shall apply.

1.2 Racing rules(s) will be changed as follows:

- a) RRS 44.1 is changed so that the two-turns penalty is replaced by the one-turn penalty.
- b) When flag 'D' is displayed ashore, this means "boats shall not leave the harbour. Wait for further instructions". This adds to race signals.



1.3 **Sails for 29er State Championship**

Two mainsails, two jibs (Avalon Sails jib permitted) and one gennaker are permitted for use.

- 1.4 Boats are required to display the following advertising that will be provided by the OA at registration and shall be fixed in accordance with the instructions provided in Attachment F:
- i. Ron Tough Yachting Foundation boom stickers for all competing boats.
 - ii. Monkeyfist.com.au bow stickers for boats competing in the Optimist State Championships.

2. NOTICE TO COMPETITORS

Notices to competitors will be posted on the official noticeboard located on the west wall of the Centreboard Clubhouse. The race office is the On Water Group (OWG) office located in the main clubhouse and on the event webpage:

<https://sopyc.com.au/75th-anniversary-sailing-carnival/>

3. CHANGES TO SAILING INSTRUCTIONS

Any change to Sailing Instructions (SIs) will be posted not less than **1** hours before the scheduled warning signal on the day it will take effect, except that any change to the schedule of races will be posted by 1800 on the day before it will take effect.

4. SIGNALS MADE ASHORE

4.1 Signals made ashore will be displayed from the signal mast on the Centreboard Clubhouse west lawn.

4.2 When flag 'AP' is displayed ashore, '1 minute' is replaced with 'not less than 30 minutes' in the race signal 'AP'.

4.3 When flag 'D' is displayed ashore this means, "boats shall not leave the harbour. Wait for further instructions". This adds to race signals. [DP]



5. SCHEDULE OF RACES

5.1 The schedule of races is detailed in Attachment A.

5.2 To alert boats that a race or sequence of races will begin soon, the orange starting line flag will be displayed with one sound signal at least 1 minute before a warning signal is made.

5.3 Registrations will be in the Centreboard Clubhouse between 1630 and 1900 on the day before the first race for each event.

6. CLASS FLAGS

6.1 Class flags are detailed in Attachment B.

6.2 Competitors in the Optimist Intermediate fleet shall fly a pink-coloured streamer attached to the top of their sprit. The streamer will be supplied by the Organising Authority (OA).

7. COURSE AREAS

7.1 The locations of the course areas are shown in Attachment C.

7.2 The Race Committee may reassign an event to any course area no later than **1** hour before the scheduled starting signal or if flag AP is displayed ashore, 30 minutes before flag AP for that event is removed.

8. THE COURSES

8.1 The diagrams in Attachment D show the courses, including the approximate angles between legs, the order in which marks are to be passed, and the side on which each mark is to be left.

8.2 If one of the gate marks is not laid, then the laid mark must be left to port.

8.3 The course to be sailed will be designated as detailed in the table below:

Event	Course Designation
Skiff Regatta	No course signal displayed
Open Regatta	Numeral Pennant below class flag
Optimist States	Course Board
Youth & Laser Open Regatta	Course Board
Open Skiff Regatta	Numeral Pennant below class flag
Foil Fest	No course signal will be displayed

8.4 Courses will not be changed after the preparatory signal for the Optimist State Championship. This changes RRS33.

9. MARKS

Refer to Attachment E.

10. AREAS THAT ARE OBSTRUCTIONS [DP]

There are no obstructions.

11. THE START

11.1 Races will be started by using RRS 26.

11.2 The starting line will be between a staff displaying an orange flag on the Race Committee boat at the starboard end and a black & white chequered inflatable buoy at the port end.

11.3 Boats whose warning signal has not been made shall avoid the starting area during the starting sequence for other races. [SCP]

11.4 A boat that does not start within 3 minutes after her starting signal will be scored Did Not Start (DNS) without a hearing. This changes RRS A4 and A5.

11.5 A buoy may be attached to the Race Committee boat. Boats shall not pass between this buoy and the Race Committee boat at any time.

12. CHANGE OF THE NEXT LEG OF THE COURSE

To change the next leg of the course, the Race Committee will lay a new mark (or move the finishing line) and remove the original mark as soon as practicable. When in a subsequent change a new mark is replaced, it will be replaced by an original mark.

13. THE FINISH

13.1 The finishing line will be between a staff displaying an orange flag on the Race Committee boat and a black & white inflatable buoy.

13.2 [Foil Fest XRS Course only] The finishing line will be between a staff displaying an orange flag on the Race Committee boat and a yellow inflatable conical buoy.

13.3 [29er State Championship] When signal flag 'W' is displayed with two sound signals on the Race Committee boat, boats that are yet to finish may be scored a finishing place in the race at that time relative to their position within the fleet. This Changes RRS Appendix A3, A4 & A5.

14. PENALTY SYSTEM

14.1 RRS 44.1 is changed so that the Two-Turns Penalty is replaced by the One-Turn Penalty.

14.2 Appendix T – Arbitration shall apply.

14.3 [DP] Discretionary Penalty – the penalty for a breach of this rule may at the discretion of the Protest Committee (PC), be less than disqualification.

14.4 [SCP] Scoring Penalty – for some specific breaches of the rules, the Race Committee (RC) may apply a scoring penalty [SCP] without a hearing. The Race Committee may still protest a boat when they considered the SCP inappropriate. A boat may request redress when they believe the application of the SCP improper. The scoring penalty is 20% of the number of boats that started, but not worse than disqualification. This changes RRS 63.1 & Appendix A5.

14.5 [NP] Breaches of the SI's marked [NP] will not be grounds for a protest by a boat. This changes RRS 60.1 (a).

15. TIME LIMITS AND TARGET TIMES

15.1 Time limits and target times, in minutes, are as follows:

EVENT	TIME LIMIT 1 ST BOAT	FINISH WINDOW	TARGET TIME
Skiff Regatta	50	15	30
Open Regatta	50	15	45
Optimist States	50	15	35
Youth & Laser Open Regatta	50	15	30
Open Skiff Regatta	50	15	30
Foil Fest	50	15	30

If no boat sails the course and finishes within the Time Limit for the first boat then the race will be abandoned.

- 15.2 Boats failing to finish within the time stated in the finish window after the first boat sails the course and finishes will be scored Did Not Finish (DNF) without a hearing. This changes RRS 35, A4 and A5.
- 15.3 Failure to meet target times will not be grounds for redress. [NP]

16. PROTESTS AND REQUESTS FOR REDRESS

- 16.1 Protest forms are available at the Centreboard Clubhouse. Protests and requests for redress or reopening shall be delivered to the On Water Group office within the appropriate time limit.
- 16.2 For each class the protest time limit is 60 minutes after the last boat has finished the last race of the day or the race committee signals no more racing today, whichever is later.
- 16.3 Notices will be posted no later than 30 minutes after the protest time limit to inform competitors of hearings in which they are parties or named as witnesses. Hearings will be held in the Protest Room located in the main clubhouse beginning at the time posted.
- 16.4 Notices of protests by the Race Committee, Technical Committee or Protest Committee will be posted to inform boats under RRS 61.1(b).

17. SCORING

- 17.1 The low point scoring system, Appendix A shall apply.
- 17.2 Three races are required to be completed to constitute a series.
- 17.3 When fewer than 4 races have been completed, a boat's series score will be the total of her race scores.
- 17.4 When from 4 to 8 races have been completed, a boat's series score will be the total of her race scores excluding her worst score.
- 17.5 When 9 or more races have been completed, a boat's series score will be the total of her scores excluding her 2 worst scores.
- 17.6 Requests for scoring review may be lodged with the Race Office via the online link below:
<https://sopyc.com.au/scoring-enquiry/>

18. SIGN ON AND SIGN OFF [SCP]

- 18.1 "Sign on/off" – A boat shall complete the "sign on/off" electronically via the link below:
<https://topyacht.com.au/tyow/427>
- 18.2 "Sign On" will be available at least 1 hour before the 1st warning signal of the day.
- 18.3 Boats shall "Sign Off" before the protest time limit expires for their class each day.
- 18.4 Retirement from a race – A boat that retires shall notify a Race Committee boat and complete the "Sign Off" immediately upon returning to shore.
- 18.5 Boats that fail to "Sign On or Off" shall receive a [SCP] without a hearing for each breach.

19. REPLACEMENT OF CREW OR EQUIPMENT [DP]

Substitution of competitors will not be allowed without prior written approval of the Race Committee. Requests for substitution shall be made to the committee at the first reasonable opportunity.

Substitution of damaged or lost equipment will not be allowed unless authorised by the Race Committee. Requests for substitution shall be made to the committee at the first reasonable opportunity.

20. OFFICIAL BOATS [NP]

Official boats will be marked 'Safety'.

21. SUPPORT BOATS [DP]

21.1 Support and coach boats shall register online with the OA at:

<https://sopyc.com.au/75th-anniversary-sailing-carnival/>

21.2 All support and coach boats shall keep clear of the racing areas while boats are racing (except when rendering assistance to a boat in distress).

21.3 Support and coach boats shall remain at least 50 metres outside areas where boats are racing from the time of preparatory signal until all boats have finished or the Race Committee signals a postponement, general recall or abandonment.

21.4 All support and coach boats are required to have VHF radio and maintain a listening watch on VHF Ch. 69 or any other channel specified by the Race Committee.

21.5 All occupants of support / coach boats less than 6m LOA shall wear an approved pfd whilst afloat.

21.6 When requested by the Race Committee, support and coach boats shall render assistance as and when required.

22. TRASH DISPOSAL

Trash may be placed aboard support or official boats.

23. DISCLAIMER OF LIABILITY

Competitors participate in the regatta entirely at their own risk. See RRS 3, Decision to Race.

The Organising Authority will not accept any liability for material damage or personal injury or death sustained in conjunction with or prior to, during, or after the regatta.

24. INSURANCE

Each participating boat shall be insured with a valid third-party liability insurance with a minimum cover of AUD10 million per incident or the equivalent.

25. MEDIA DISCLAIMER

Competitors agree to grant the Organising Authority the right in perpetuity to make use, use and show, from time to time and at their discretion, any motion pictures, still pictures and live, taped or film television and other reproductions of the athlete during the period of the competition without compensation.

26. AMENDMENTS

Any amendment to these Sailing Instructions will be posted on the event website:

<https://sopyc.com.au/75th-anniversary-sailing-carnival/>

27. FURTHER INFORMATION

For further information, please contact:

On Water Group

South of Perth Yacht Club

Coffee Point, Applecross

Phone: + 61 (08) 9364 5844

Email: sailingadministrator@sopyc.com.au

ATTACHMENTS:

Attachment A – Schedule of Races

Attachment B – Class Flags

Attachment C – Race Areas

Attachment D – The Courses

Attachment E – Marks

Attachment F - Advertising

ATTACHMENT A - SCHEDULE OF RACES

GOOLUGATUP SAILING CARNIVAL

SKIFF REGATTA

29er, Cherub, International 14, Javelin

DATE	RACE NO.	COURSE AREA	COURSE TYPE	1 st WARNING	NO WARNING AFTER
Mon 4 Jan	Up to 2 races	Melville Water East	W/L	1330	1600
Tue 5 Jan	Up to 2 races	Melville Water East	W/L	1330	1600
Wed 6 Jan	Lay Day	-	-	-	-
Thu 7 Jan	Up to 2 races	Melville Water East	W/L	1330	1600
Fri 8 Jan	Up to 2 races	Melville Water East	W/L	1330	1600

There will be a maximum of 8 races

OPEN REGATTA

Flying Fifteen, 505, Sharpies

DATE	RACE NO.	COURSE AREA	COURSE TYPE	1 st WARNING	NO WARNING AFTER
Mon 4 Jan	Up to 2 races	Melville Water West	W/L/Tri	1330	1600
Tue 5 Jan	Up to 2 races	Melville Water East	W/L/Tri	0930	1200
	Up to 2 races	Melville Water West	W/L/Tri	1330	1600
Wed 6 Jan	Lay Day	-	-	-	-
Thu 7 Jan	Up to 2 races	Melville Water West	W/L/Tri	1330	1600
Fri 8 Jan	Up to 2 races	Melville Water East	W/L/Tri	0930	1200

There will be a maximum of 10 races

OPTIMIST STATE CHAMPIONSHIP

Optimist Open, Intermediate

DATE	RACE NO.	COURSE AREA	COURSE TYPE	1 st WARNING	NO WARNING AFTER
Sat 9 Jan	Up to 3 races	Melville Water East	Trapezoid	0930	1200
	Up to 3 races	Melville Water East	Trapezoid	1330	1600
Sun 10 Jan	Up to 3 races	Melville Water East	Trapezoid	0930	1200
	Up to 3 races	Melville Water East	Trapezoid	1330	1600
Mon 11 Jan	Up to 3 races	Melville Water East	Trapezoid	0930	1300

There will be a maximum of 10 races

YOUTH & LASER OPEN REGATTA

Laser Standard, Laser 4.7, Laser Radial, 29er

DATE	RACE NO.	COURSE AREA	COURSE TYPE	1 st WARNING	NO WARNING SIGNAL
Sun 10 Jan	Up to 2 races	Melville Water West	Trapezoid	1330	1600
Mon 11 Jan	Up to 2 races	Melville Water West	Trapezoid	1330	1600
Tue 12 Jan	Up to 2 races	Melville Water West	Trapezoid	1330	1600
Wed 13 Jan	Up to 2 races	Melville Water West	Trapezoid	1330	1600
Thu 14 Jan	Up to 2 races	Melville Water West	Trapezoid	1330	1600

There will be a maximum of 10 races



75
YEARS
1945 ~ 2020

The *Ron Tough*
Yachting Foundation



ATTACHMENT A - SCHEDULE OF RACES

GOOLUGATUP SAILING CARNIVAL

OPEN SKIFF & ~~LASER OPEN REGATTA~~

~~Laser Standard, Laser Radial,~~ Open Skiff

DATE	RACE NO.	COURSE AREA	COURSE TYPE	1 st WARNING	NO WARNING AFTER
Tue 12 Jan	Up to 2 races	Melville Water East	W/L/Tri	1330	1600
Wed 13 Jan	Up to 2 races	Melville Water East	W/L/Tri	1330	1600
Thu 14 Jan	Up to 2 races	Melville Water East	W/L/Tri	1330	1600

There will be a maximum of 6 races

FOIL FEST

Windfoil & Kitefoil

DATE	RACE NO.	COURSE AREA	COURSE TYPE	1 st WARNING	NO WARNING AFTER
Tue 12 Jan	Up to 4 races	Melville Water West	W/L	1630	1830
Wed 13 Jan	Up to 4 races	Melville Water West	W/L	1630	1830
Thu 14 Jan	Up to 4 races	Melville Water West	XRS	1630	1830

There will be a maximum of 12 races



75
YEARS
1945 ~ 2020

The *Ron Tough*
Yachting Foundation



ATTACHMENT B – CLASS FLAGS

GOOLUGATUP SAILING CARNIVAL

SKIFF REGATTA



29er



Cherub



I14



Javelin

OPEN REGATTA



Flying Fifteen



505



Sharpie

OPTIMIST STATE CHAMPIONSHIP



Optimist



Intermediate + Pink Streamer

YOUTH & LASER OPEN REGATTA



Laser Standard



Laser 4.7



Laser Radial



29er

OPEN SKIFF REGATTA



Open Skiff

FOIL FEST



Windfoil



Kitefoil

ATTACHMENT C

ALLOCATION OF EVENTS TO COURSE AREAS

GOOLUGATUP SAILING CARNIVAL



Refer to Attachment A for allocation of events to course areas.



75
YEARS
1945 ~ 2020

The *Ron Tough*
Yachting Foundation



ATTACHMENT D – THE COURSES

SKIFF REGATTA

(Including the 29er State Championship)

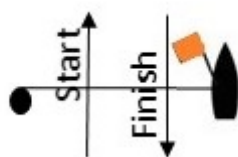
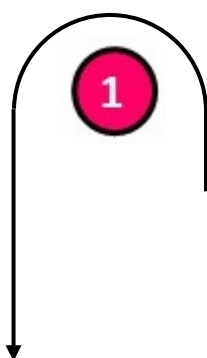
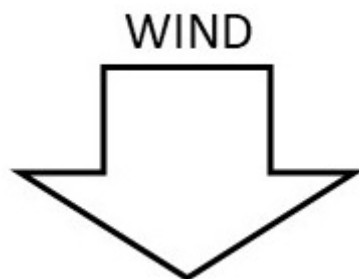

Course



Start – 1 – 2s/2p – 1 - Finish

ATTACHMENT D – THE COURSES

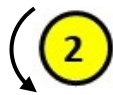
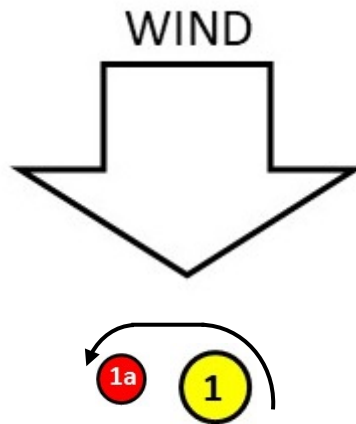
OPEN REGATTA



Courses

Flying 15	1		Start – 1 – 1a – 3 – 1 – 1a – 2 – 3 – Finish
Flying 15	2		Start – 1 – 1a – 3 – 1 – 1a – 2 – 3 – 1 – 1a – 3 – Finish

ATTACHMENT D – THE COURSES

OPTIMIST STATE CHAMPIONSHIP

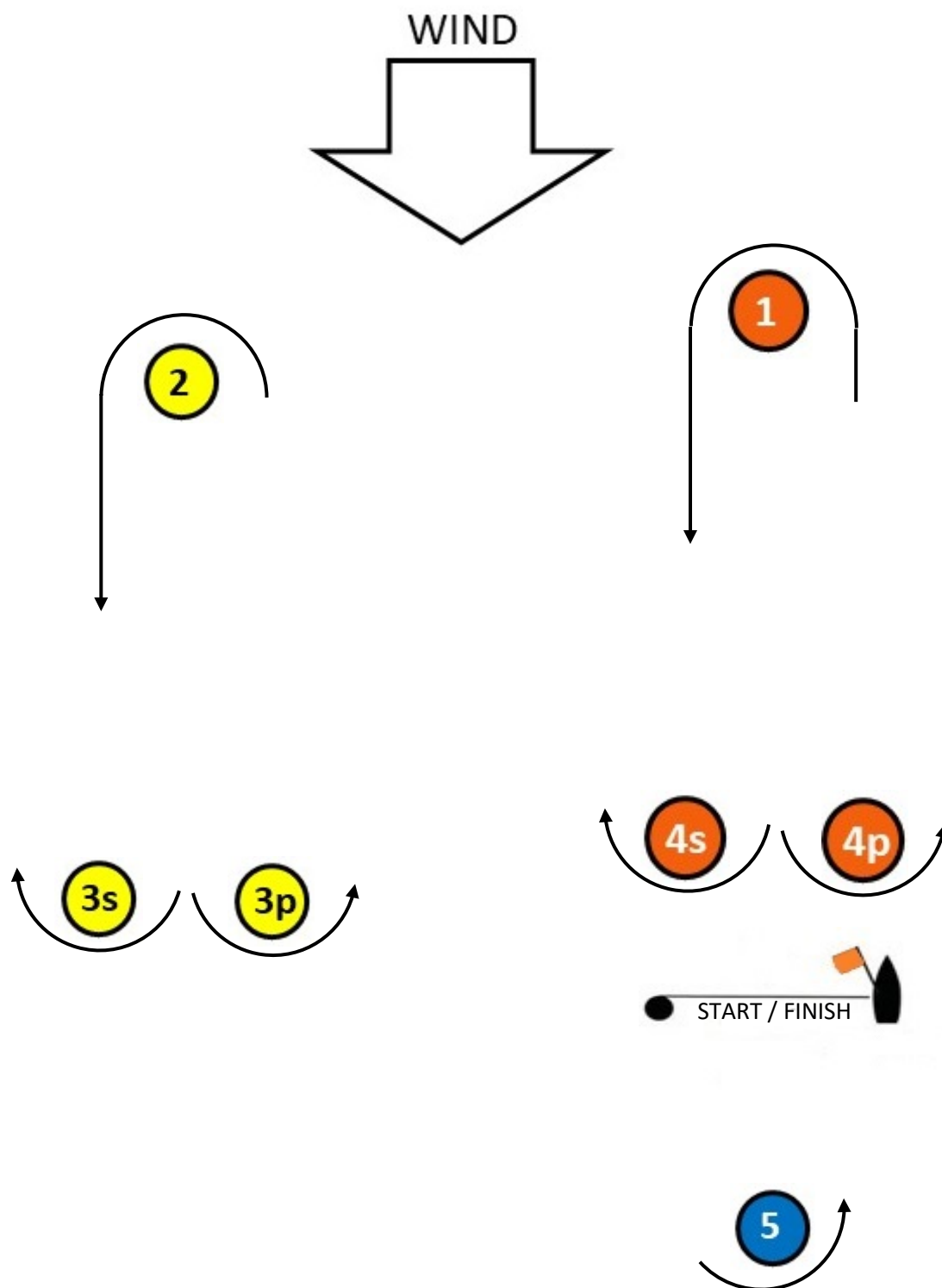

COURSES

Optimist Intermediate

Course O 1 Start – 1 – 2 – 3p – 5 – Finish

Course O 2 Start – 1 – 2 – 3s/3p – 2 – 3p – 5 – Finish

Optimist Open

Course I 2 Start – 1 – 4s/4p – 1 – 2 – 3p – 5 – Finish

Course I 3 Start – 1 – 4s/4p – 1 – 4s/4p – 1 – 2 – 3p – 5 – Finish

ATTACHMENT D – THE COURSES

YOUTH & LASER OPEN REGATTA

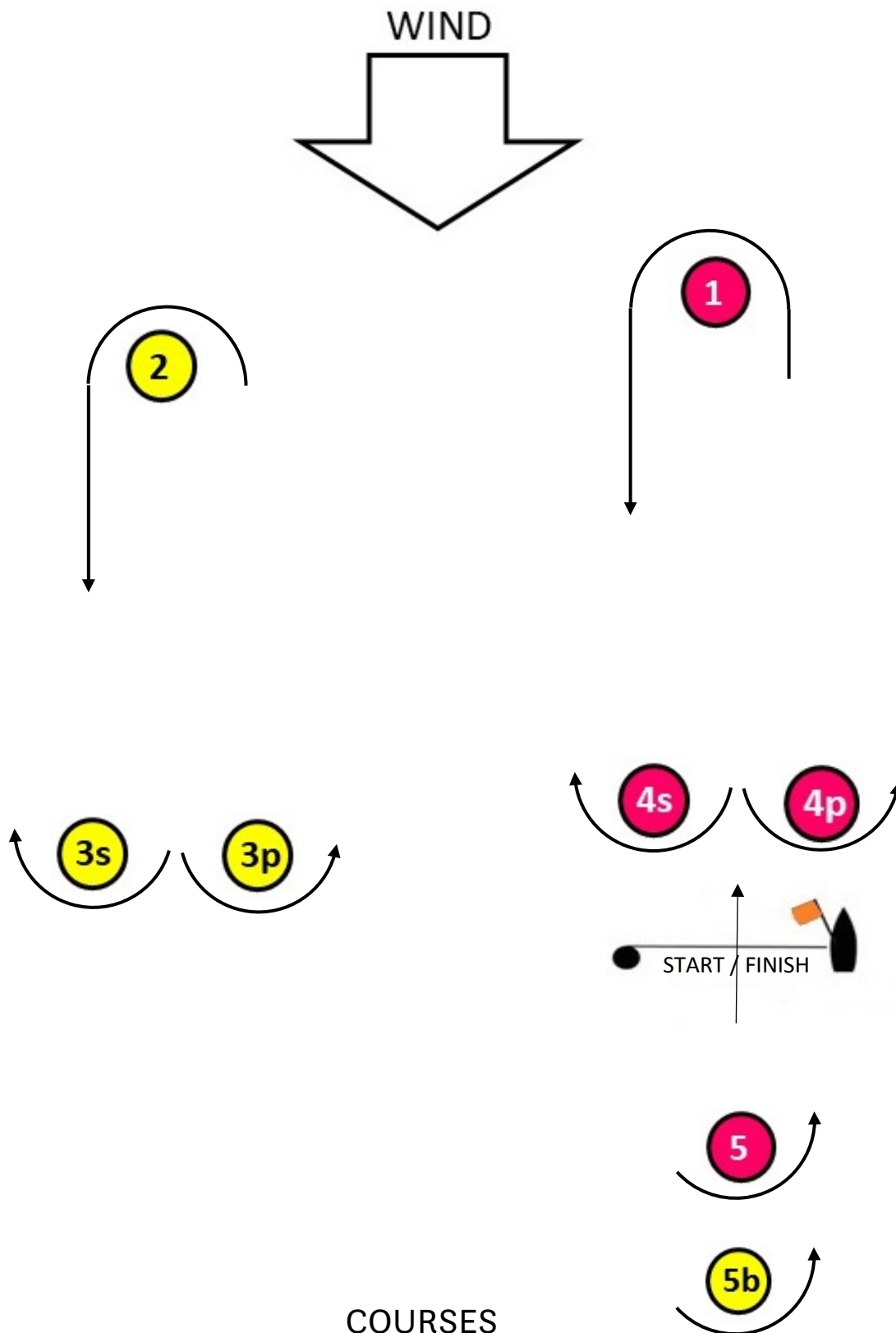

COURSES

29er
29er

Course I 2 Start – 1 – 4s/4p – 1 – 5 – Finish

Course I 3 Start – 1 – 4s/4p – 1 – 4s/4p – 1 – 5 – Finish

Laser Classes
Laser Classes

Course 0 1 Start – 1 – 2 – 3s/3p – 2 – 3p – 5b – Finish

Course 0 2 Start – 1 – 2 – 3s/3p – 2 – 3s/3p – 2 – 3p – 5b – Finish

ATTACHMENT D – THE COURSES

OPEN SKIFF REGATTA

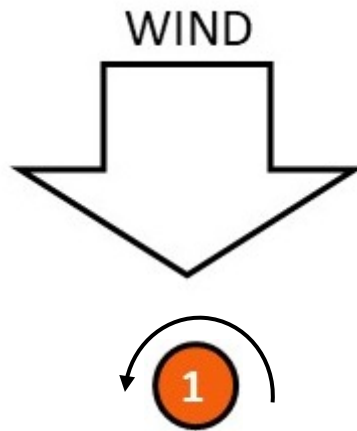

Courses

Open Skiff 1  Start – 1 – 3 – 1 – 2 – 3 – Finish

Open Skiff 2  Start – 1 – 3 – 1 – 3 – 1 – 2 – 3 – Finish

ATTACHMENT D – THE COURSES

FOIL FEST

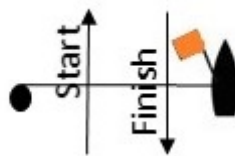
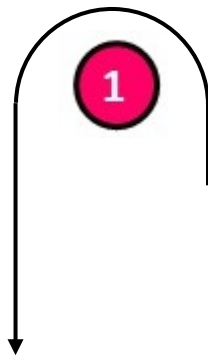
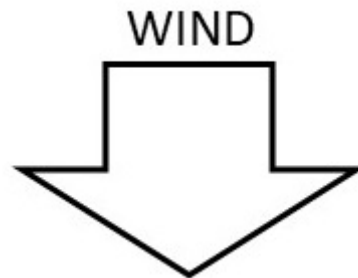

Course

Start – 1 – 2s/2p – 1 - Finish

ATTACHMENT D – THE COURSES

FOIL FEST

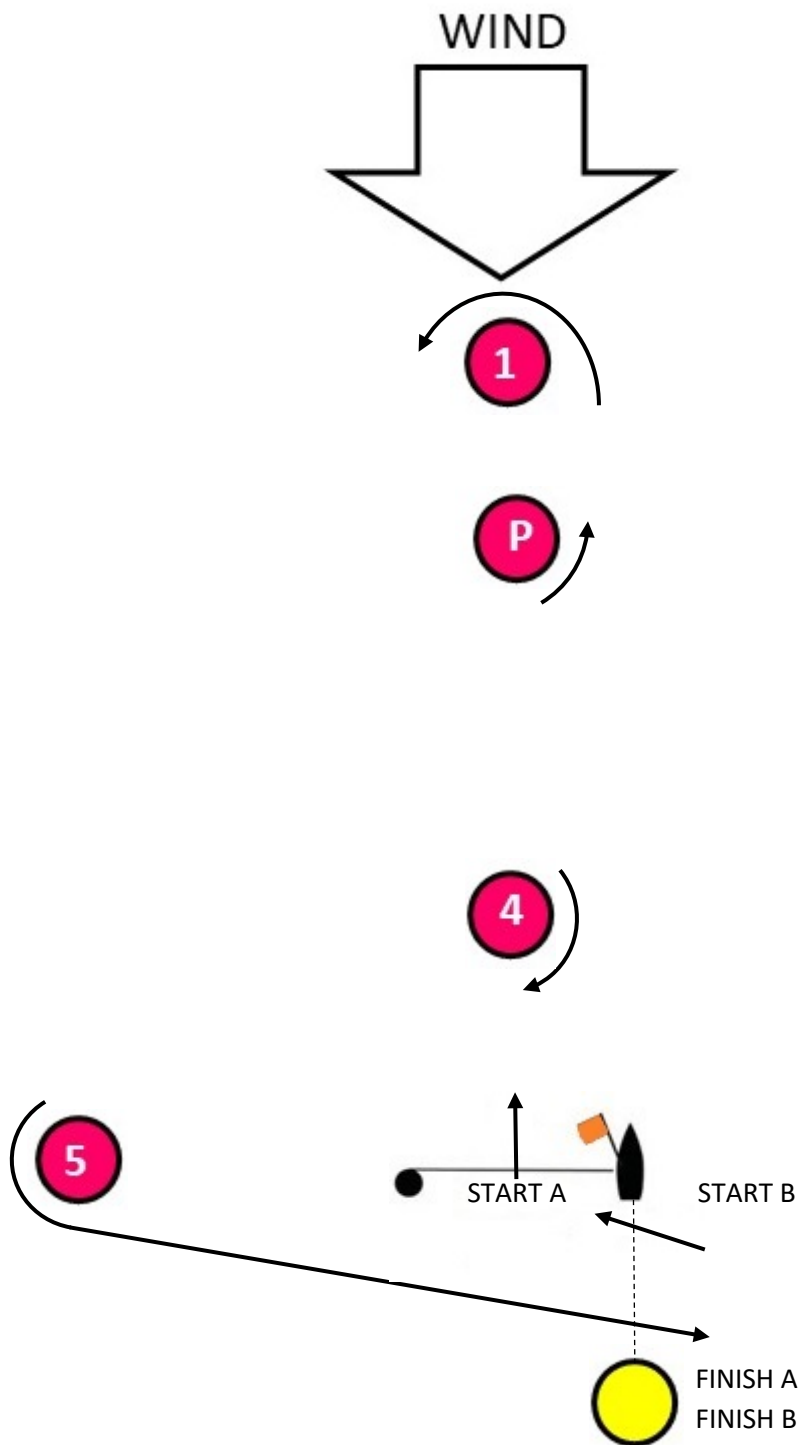

XRS Course

Kitefoil Course: Start A – Pp – 1p – Pp – 4s – 5p – Finish A – Start B – Pp – 1p – Pp – 4s – 5p – Finish B

Windfoil Course: Start A – Pp – 1p – 4s – 1p – 4s – 5p – Finish A

ATTACHMENT E - MARKS

GOOLUGATUP SAILING CARNIVAL

SKIFF REGATTA

29er, Cherub, International 14, Javelin

MARKS	DESCRIPTION	COLOUR
1	Inflatable conical buoy	Pink
2s/2p	Inflatable conical buoys	Pink
New	Inflatable conical buoy as described in SI12	Green

OPEN REGATTA

Flying Fifteen, 505, Sharpies

MARKS	DESCRIPTION	COLOUR
1	Inflatable conical buoy	Yellow
1a	Inflatable cylindrical buoy	Red
2	Inflatable conical buoy	Yellow
3	Inflatable conical buoy	Blue
New	Inflatable conical buoy as described in SI12	Green

OPTIMIST STATE CHAMPIONSHIP

Optimist Open, Intermediate

MARKS	DESCRIPTION	COLOUR
1	Inflatable conical buoy	Orange
2	Inflatable conical buoy	Yellow
3s/3p	Inflatable conical buoys	Yellow
4s/4p	Inflatable conical buoys	Orange
5	Inflatable conical buoy	Blue

YOUTH & LASER OPEN REGATTA

Laser Standard, Laser 4.7, Laser Radial, 29er

MARKS	DESCRIPTION	COLOUR
1	Inflatable conical buoy	Pink
2	Inflatable conical buoy	Yellow
3s/3p	Inflatable conical buoys	Yellow
4s/4p	Inflatable conical buoys	Pink
5	Inflatable conical buoy	Pink
5b	Inflatable conical buoy	Yellow
New	Inflatable conical buoy as described in SI12	Green



75
YEARS
1945 ~ 2020

The *Ron Tough*
Yachting Foundation



ATTACHMENT E - MARKS

GOOLUGATUP SAILING CARNIVAL

OPEN SKIFF REGATTA

Open Skiff

MARKS	DESCRIPTION	COLOUR
1	Inflatable conical buoy	Orange
2	Inflatable conical buoy	Orange
3	Inflatable conical buoy	Orange
New	Inflatable conical buoy as described in SI12	Green

FOIL FEST

Windfoil & Kitefoil

Windward / Leeward Course		
MARKS	DESCRIPTION	COLOUR
1	Inflatable conical buoy	Pink
2s/2p	Inflatable conical buoys	Pink
New	Inflatable conical buoy as described in SI12	Green

XRS Course		
MARKS	DESCRIPTION	COLOUR
1	Inflatable conical buoy	Pink
4	Inflatable conical buoy	Pink
5	Inflatable conical buoy	Pink
P	Inflatable conical buoy	Pink



75
YEARS
1945 ~ 2020

The *Ron Tough*
Yachting Foundation



ATTACHMENT F – ADVERTISING

GOOLUGATUP SAILING CARNIVAL

Ron Tough Yachting Foundation preferred boom sticker placement for all competing boats attached to each side of the boom.



MonkeyFist bow sticker placement for Optimists.

Place 1 (one) bow sticker on each side of the hull, anywhere within the (300mm x 930mm) boxes depicted below.

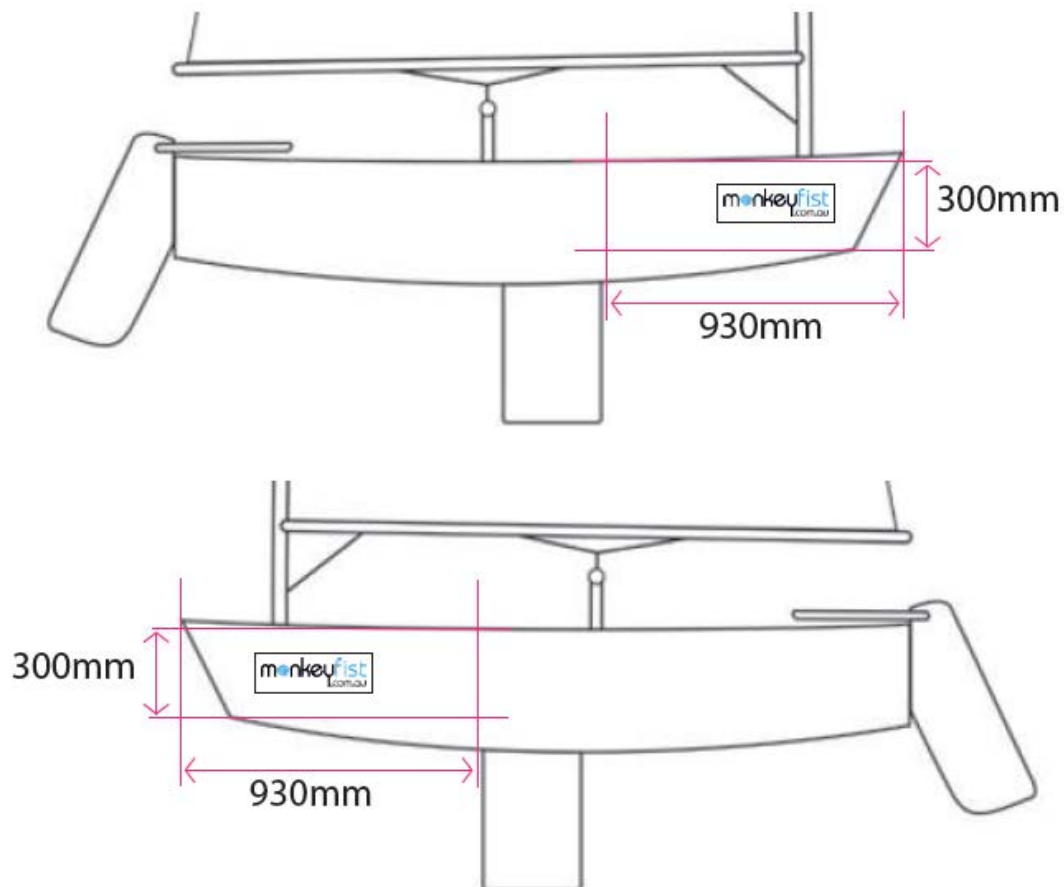

75
YEARS
1945 ~ 2020

The *Ron Tough*
Yachting Foundation

